

- RS-7130** KELLY
- RS-7130L** length 5¹/₂"
- RS-7131** straight
- RS-7131L** left handed version
- curved
- left handed version

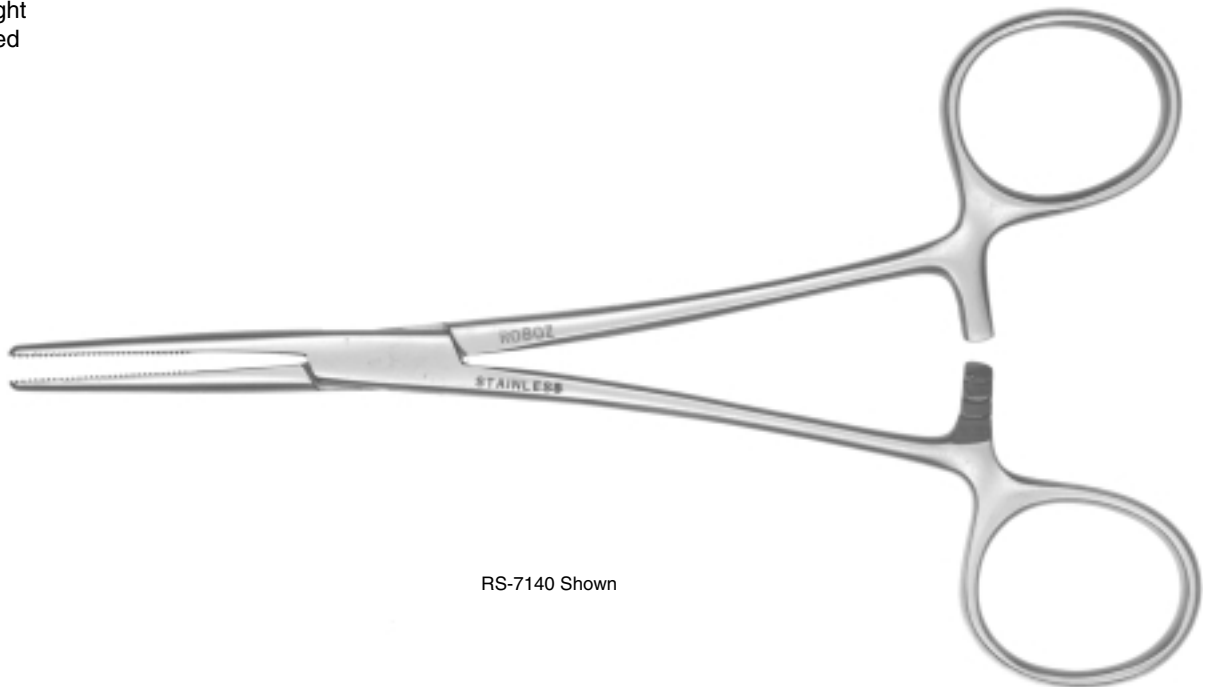

RS-7130 Shown

- RS-7140** RANKIN
- RS-7141** length 6¹/₄"
- straight
- curved



RS-7140 Shown

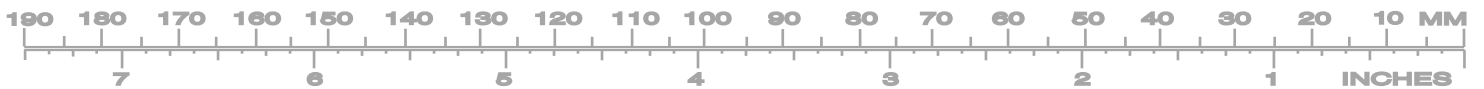

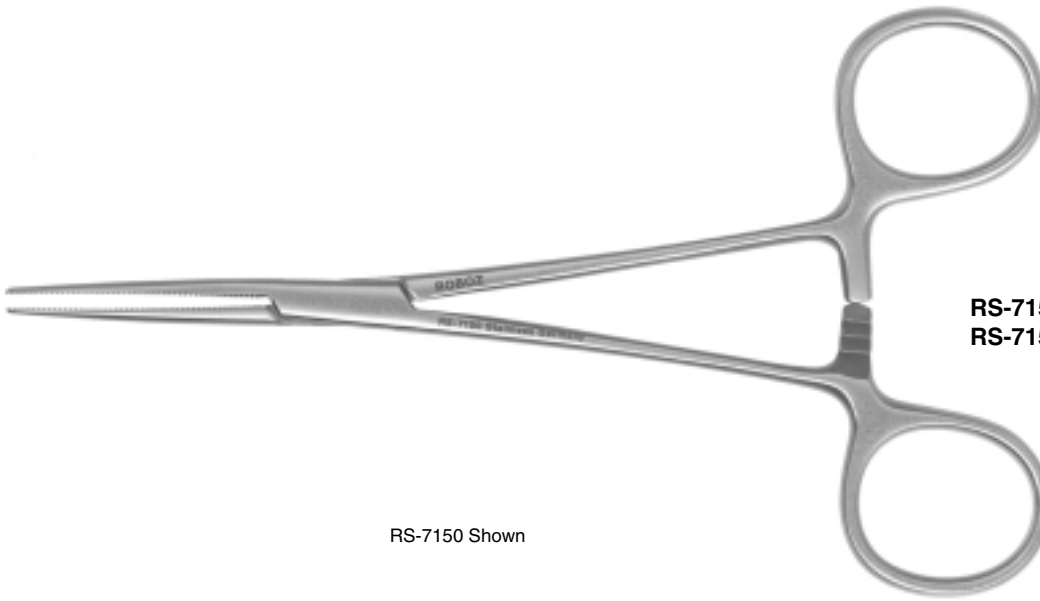

RS-7150 Shown

RS-7150
RS-7151

CRILE
extra delicate
length 5¹/₂"
straight
curved

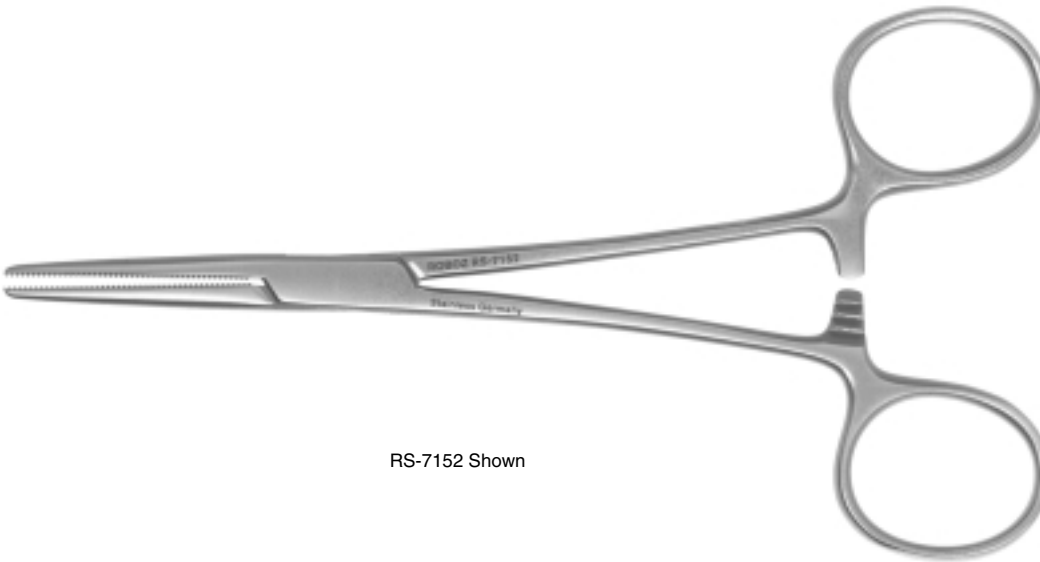

RS-7152 Shown

RS-7152

RS-7153

RS-7154

CRILE
straight
length 5¹/₂"
curved
length 5¹/₂"
straight
length 6¹/₄"

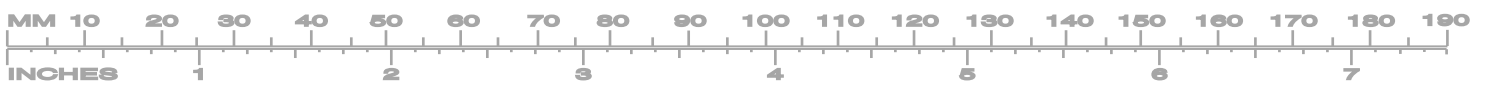

- ROCHESTER-PEAN
straight
- RS-7172 length 5¹/₂"
- RS-7174 length 6¹/₄"
- RS-7176 length 7¹/₄"
- RS-7182 length 10"

- ROCHESTER-PEAN
curved
- RS-7173 length 5¹/₂"
- RS-7175 length 6¹/₄"
- RS-7177 length 7¹/₄"
- RS-7183 length 10"

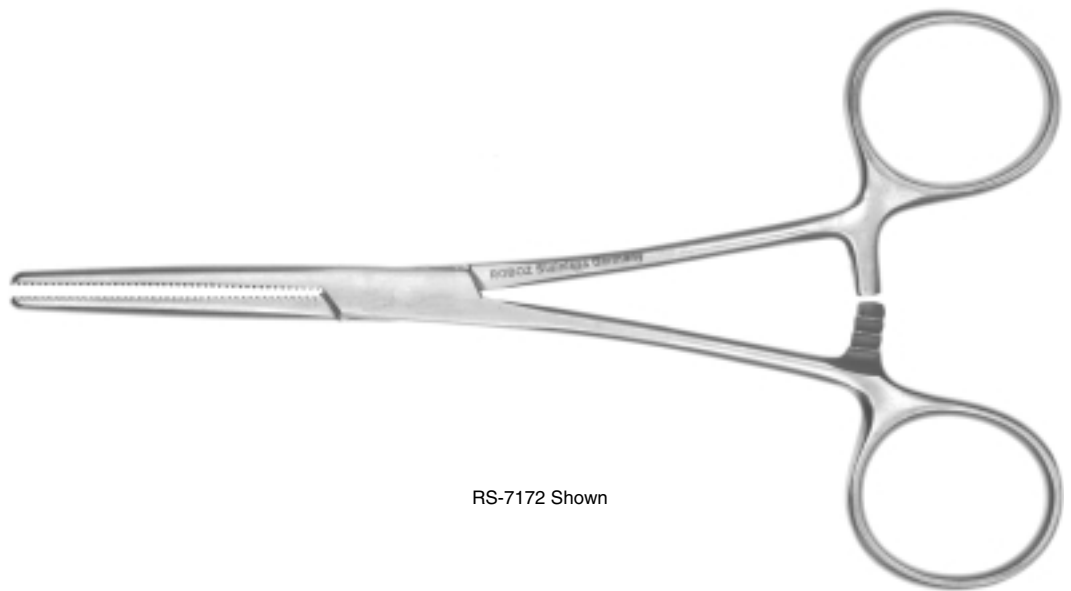

RS-7172 Shown

1-800-424-2984
www.roboz.com

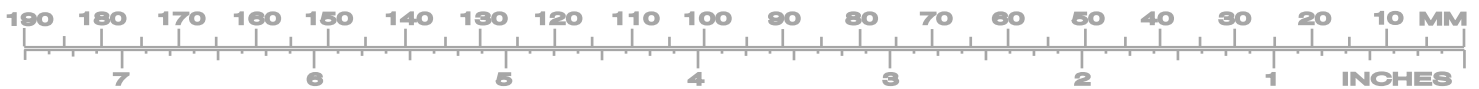

RS-7211

REYNOLDS
full-curve
length 5 1/2"



RS-7220

PENNINGTON
triangular jaws
length 6"

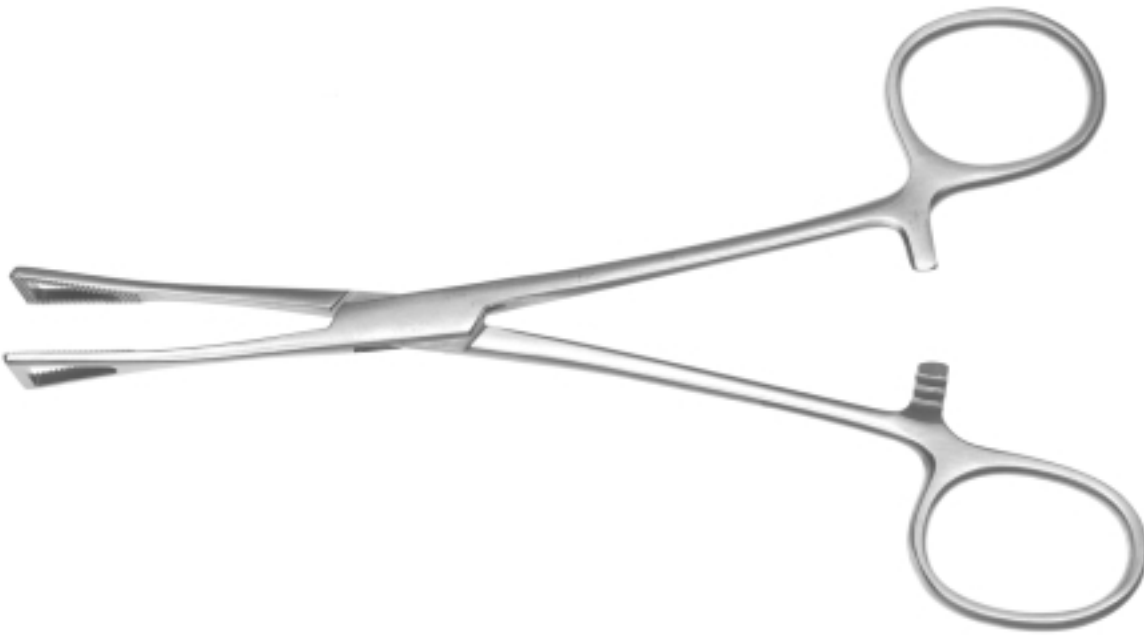

RS-7231 GEMINI-MIXTER
full curve, delicate
length 5 1/2"
RS-7233 length 7"

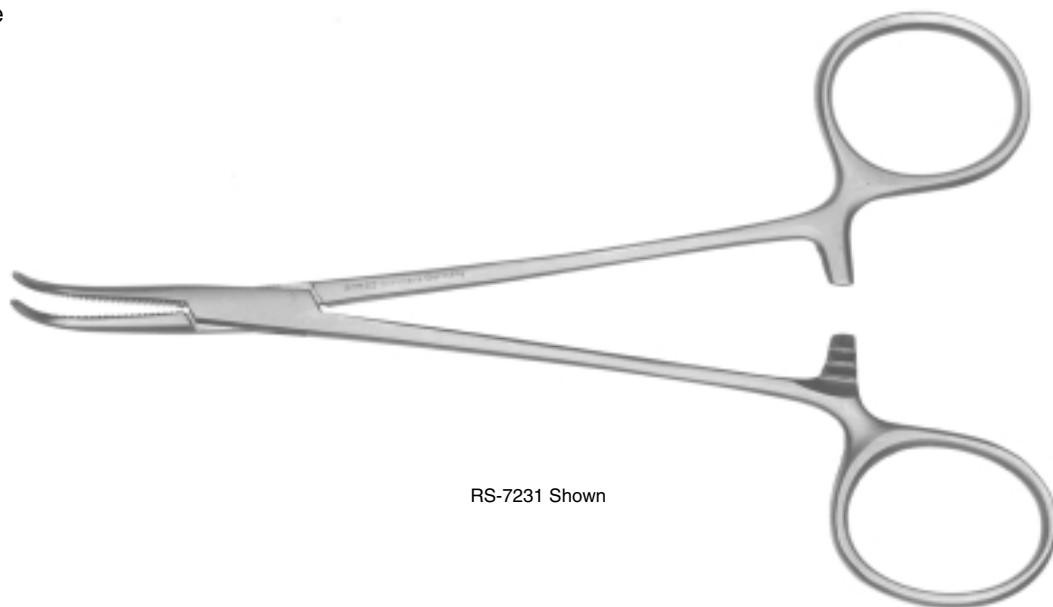

RS-7231 Shown

RS-7250 ADSON
length 7 1/4"
straight
RS-7251 curved

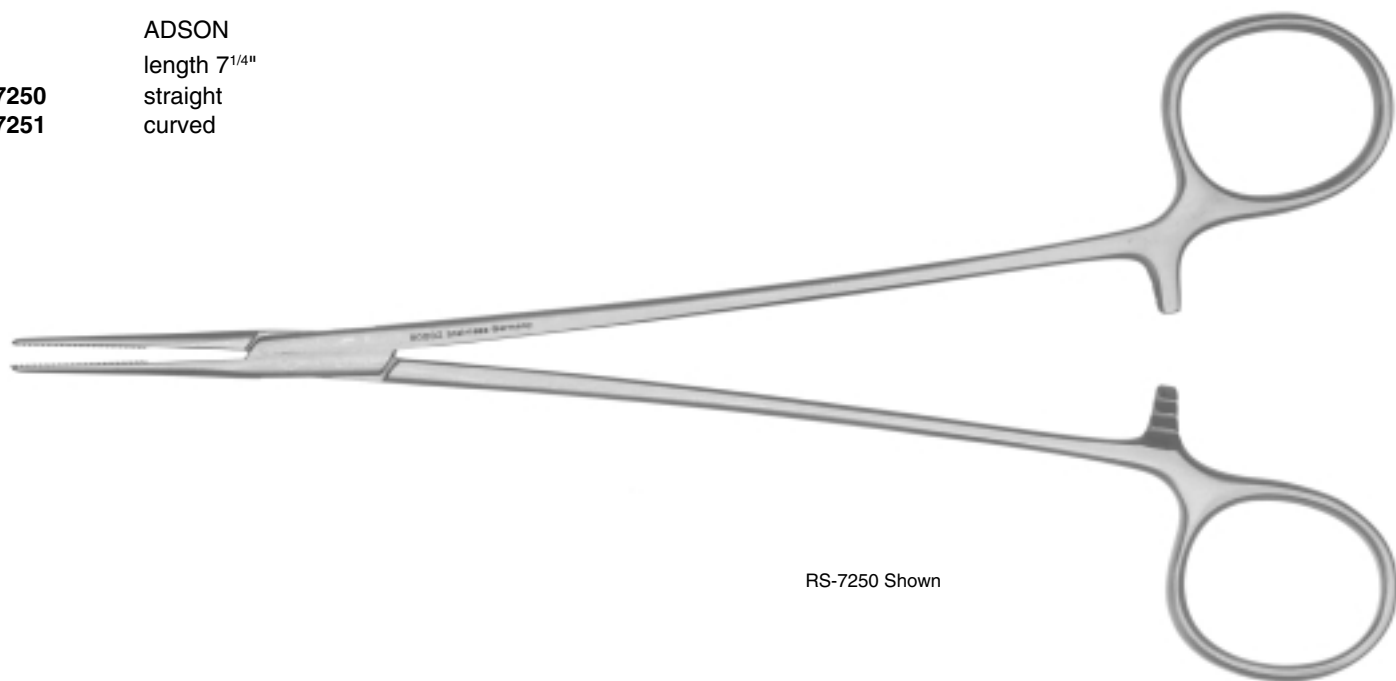

RS-7250 Shown

1-800-424-2984
www.roboz.com

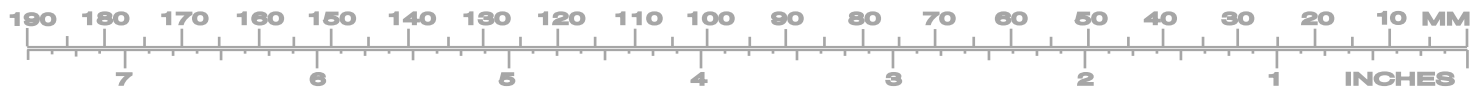

	Mosquito
	delicate
	length 8 ^{1/4"}
RS-7270	straight
RS-7271	curved

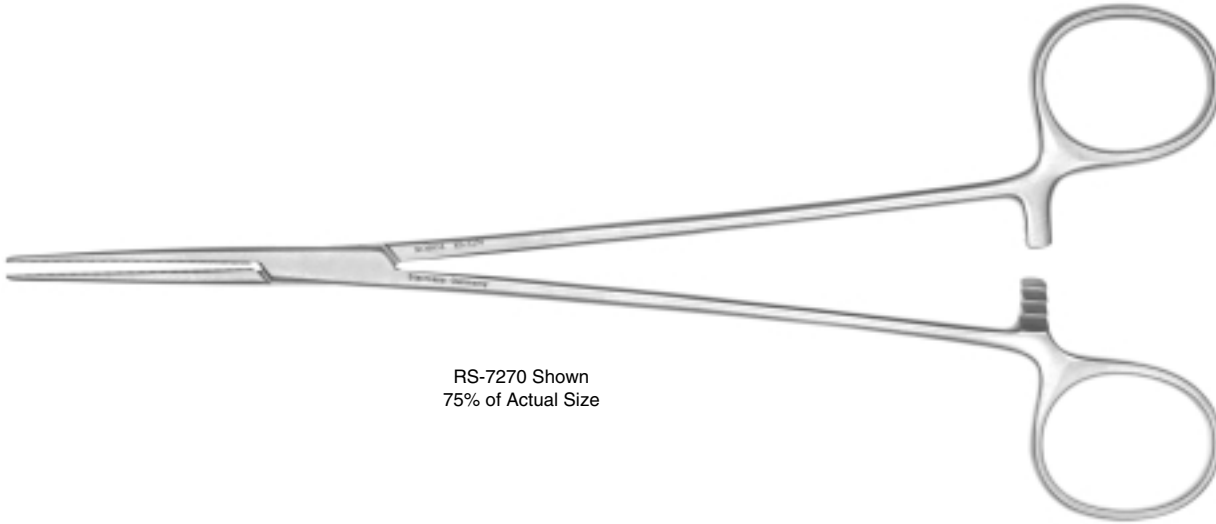

RS-7270 Shown
75% of Actual Size

RS-7291	MIXTER
	curved, extra delicate
	length 5 ^{1/2"}

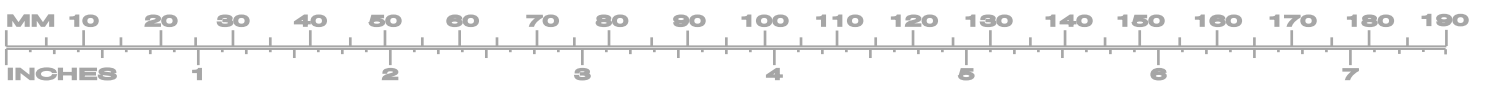

RS-7293
MIXTER
full curve
length 6¹/₄"



RS-7293 Shown

RS-7305
KANTROWITZ
delicate, 90° angle
length 7¹/₂"

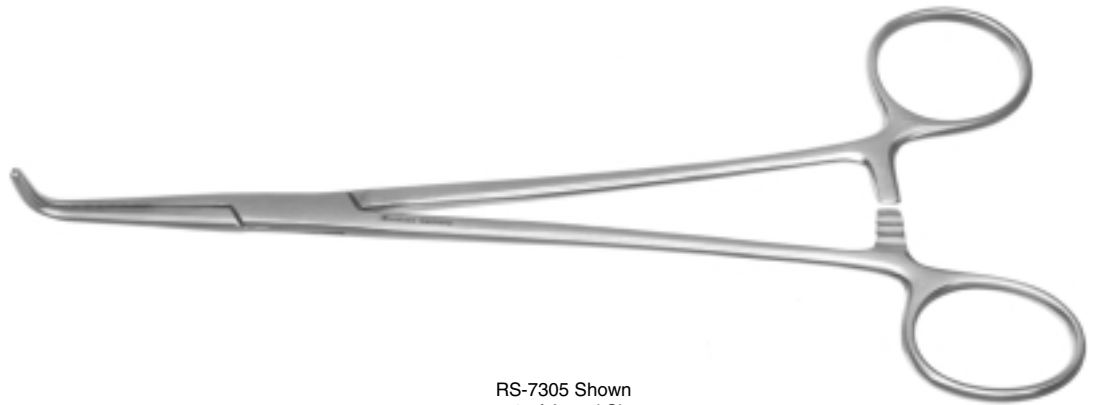

RS-7305 Shown
75% of Actual Size

1-800-424-2984
www.roboz.com

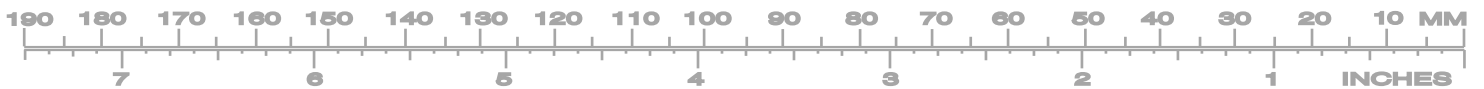

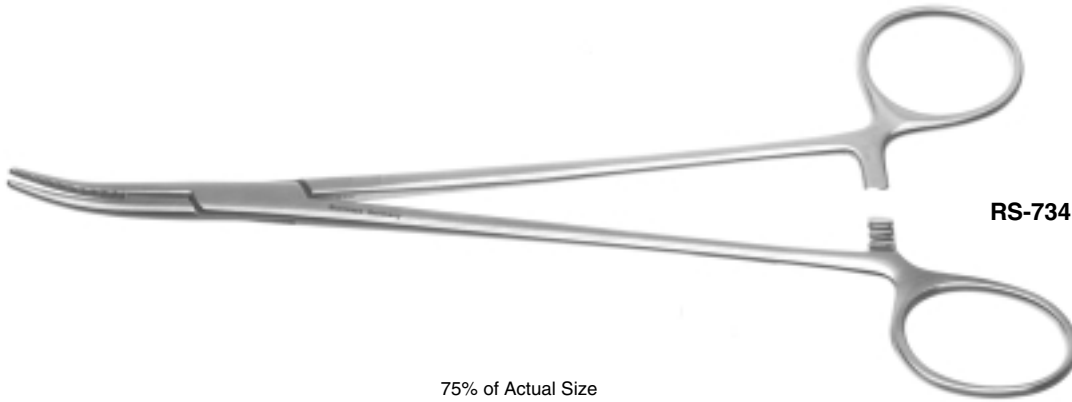

RS-7341

SCHNIDT
slight curve
length 7¹/₂"

75% of Actual Size

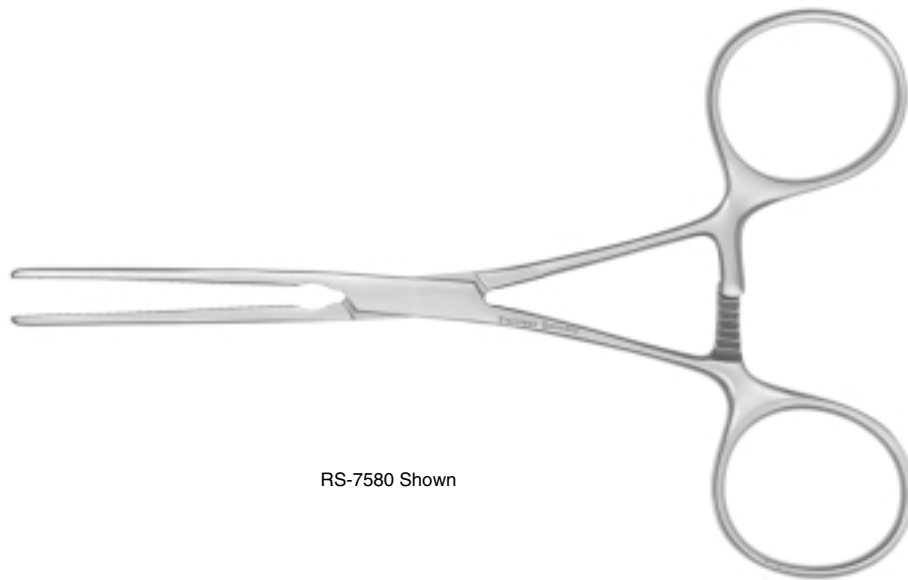

RS-7580
RS-7581

DeBAKEY
bulldog clamps
ring handle
length 4³/₄"
straight
curved

RS-7580 Shown

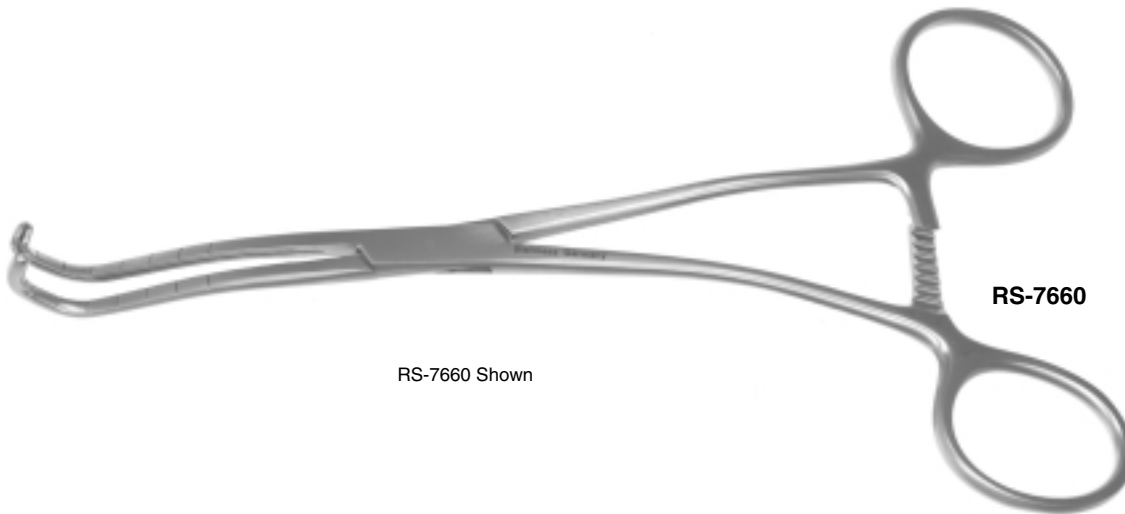

RS-7660

COOLEY-DERRA
anastomosis clamp
5mm calibrations on jaws
length 6¹/₄"
small clamp

RS-7660 Shown



Ordering Information

Phone To Order by phone call Toll Free **1-800-424-2984**
Our experienced customer support staff will courteously and efficiently assist you. Our business hours are:
8:30 a.m. to 5:30 p.m. Eastern Time

Fax Fax your purchase orders directly to:
Roboz Surgical Customer Service.
1-888-424-3121

Mail Mail your purchase orders to:
Roboz Surgical Instrument Co., Inc.
P.O. Box 10710
Gaithersburg, Maryland 20898-0710

Credit Card Roboz accepts VISA, Mastercard and American Express   

After Hours Our normal business hours are: 8:30 a.m. to 5:30 p.m. Eastern Time
Holidays & Weekends Monday through Friday. Outside normal hours please leave your name on our voice mail and a customer service representative will return your call the next business day.

Shipping & Handling We normally ship UPS two day service for a flat rate fee.
Next day service is available for an additional fee.
Shipping point is Gaithersburg, Maryland.

Returns To return any of our products please call us at 1-800-424-2984. Our customer service staff will arrange for authorization and assist you. Please use care in packaging delicate items. Also note a 10% restocking charge may apply.

Terms & Conditions **Net 30 Days**
A 1.5% charge for overdue accounts may apply.
Delivery 2-5 days ARO
F.O.B. Gaithersburg, MD